

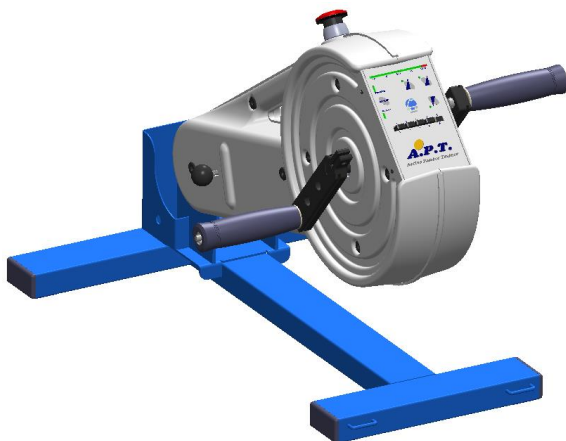

A.P.T.TM
Active Passive Trainer

APT-1K



USER'S MANUAL
Original instructions

CE 0123

Table of contents:

	Page
Section A – Pre-sales Information	5
1. Introduction	5
2. Technical Data	6
3. User Information	7
4. System Components and Details	9
5. Accessories	13
Section B – User Information	14
6. Preparing the <i>APT-1K Hi-Lo</i>	14
7. Installation for use – Arms exercise	15
8. Installation for use - Legs exercise	17
9. Operation instructions	19
10. Transportation and Storage	23
11. EMI – Electromagnetic Interference	24
Section C – Service Information	30
12. General Maintenance, Inspections and Storage	30
13. Disposing and Recycling	31
14. Trouble Shooting	32
15. Appendix – Exercise Parameter Values	33

NOTE: Design details may change without notice

SECTION A – PRE-SALES INFORMATION

1. INTRODUCTION

The **APT-1K** is an electric exercise machine used for the improvement of physical abilities. The **APT-1K** provides the user with a variety of exercise options and modes of operation that meet a broad range of physical needs.

A wide range of accessories are available that offer many exercise options and make the **APT-1K** suitable for the maintenance of fitness and physical well being.

The **APT-1K** can be operated in either the ACTIVE mode at varying degrees of resistance or in the PASSIVE mode at adjustable speed and torque levels. In the PASSIVE mode it is also possible to combine PASSIVE with ACTIVE training by using physical effort in conjunction with the electrical operation of the motor. The **APT-1K** functions forwards or backwards and is suitable for arm or leg exercises (upper or lower limbs).

The **APT-1K**'s light weight makes it portable, easy to store and convenient to use.

Use of the **APT-1K** is recommended for the maintenance of muscle strength, flexibility, muscle tone, endurance and general fitness for users of all ages.

2. TECHNICAL DATA

APT-1K	
Weight	10.2 kg (22 lbs)
Length	60 cm (23.6 in) overall
Width	47 cm (18.5 in)
Height	32 cm (12.6 in) folded
Working voltage	24 VDC
Revolutions per minute	20 - 60 RPM
Current Rating	4.16 A Max
Accuracy of measurement display	±10%
Liquid ingress protection level	IPX1



Type B equipment

External Power Supply

Weight	0.8 kg (1.8 lbs)
Length	19 cm (7.5 in)
Width	9 cm (3.5 in)
Height	4.6 cm (1.8 in)
Input:	100-240 V 47-63 Hz 1.25 A
Output:	24 VDC 100 W Max 4.16 A



Class I equipment

Continuous operation

Equipment not suitable for use in the presence of flammable anaesthetic mixture with air or with oxygen or nitrous oxide.

WARNING: To avoid the risk of electric shock, this equipment must only be connected to a supply mains with protective earth.

The **APT-1K** Active Passive Trainer and its accessories have been designed and manufactured in accordance with the specification of the following:

DIRECTIVE: Medical devices 93/42 EEC (Annex V)



3. USER INFORMATION

3.1. Intended Use

The Active Passive Trainers are electric exercise machines used for the improvement of physical abilities. The trainers provide the user with a variety of exercise options and modes of operation that meet a broad range of physical needs:

- Fitness: the maintenance of muscle strength, flexibility, muscle tone, endurance and general fitness for users of all ages;
- Rehabilitation: spinal cord injury, geriatrics, CVA, cardiac and pulmonary, paediatric, haemodialysis (training during treatment), general

3.2. Indications

The Active Passive Trainers are intended to be operated by persons of most physiques and ages. In case the user has limited strength in the arm or cognitive impairment, it is required to have an attendant present during exercise.

The Active Passive Trainers provide the user with a variety of exercise options and modes of operation that meet a broad range of physical needs. Use of the Active Passive Trainer is recommended for the maintenance of muscle strength, flexibility, muscle tone, endurance and general fitness for users of all ages.

3.3. Contraindications

People with limited cognitive abilities and children should not use the Active Passive Trainer unsupervised.

In case of any disease or physical complaints, a healthcare provider should be consulted before participating in any exercise program.

Immediately stop exercising when feeling dizzy, pains, nauseous or any other physical discomfort. In case of recurring discomforts, consult with a health care provider.

Risk analysis and long term experience in the field of movement therapy show that patients with the following indications are required to consult their doctor and therapist before starting the training:

- Fresh joint injuries
- joint replacements/prosthetics
- fresh ligament reconstruction

- fresh knee- and hip prosthetics
- knee and joint arthritis
- joint stiffness
- extreme muscle shortening
- extreme limb deformation
- increased danger of hip and shoulder luxation (e.g. sub luxation in shoulder)
- acute thrombosis
- decubitus
- very strong osteoporosis

3.4. Safety

These safety considerations and tips will help you to operate the **APT-1K** safely and prevent personal injury and damage to your wheelchair.

1. Read this manual and all labels before operating. If you do not fully understand any part of this manual, please contact your authorized dealer or service agent.
2. The **APT-1K** should not be used in the vicinity of sensitive medical equipment.
3. Electromagnetic interference (“EMI”) can cause **APT-1K** to behave erratically, which could be dangerous to the user. For your safety and protection, it is imperative that you read the information on EMI before operating the **APT-1K**, see chapter 11.
4. EMC Warning: Radio wave sources such as radio and T.V. stations, transmitters and cellular telephones can affect the performance of powered wheelchairs and mobility devices.
5. Do not operate the **APT-1K** when under the influence of alcohol, medications or drugs that may impair your safety.
6. Only the authorized dealer or service agent may perform specified set-up procedures and controller settings; programming of the settings outside the limits as specified by the manufacturer may have adverse effects on the performance.
7. Do not use the **APT-1K** if it behaves abnormally or erratically, contrary to the usual performance as described in this user manual.
8. CAUTION: Surface temperatures can increase when exposed to external sources of heat (e.g. sunlight).

4. SYSTEM COMPONENTS AND DETAILS

4.1 APT-1K unit (Figure 1)

APT-1K Hi-Lo (Figure 1A)

APT-1K Double (Figure 1B)

1. Operator panel
2. Angle release knob
3. Angle securing knob
4. Crank-arm
5. Power input socket
6. Height release knob (*Hi-Lo* only)
7. Height securing knob (*Hi-Lo* only)

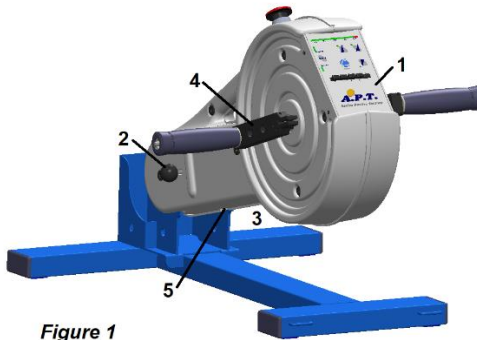

Figure 1

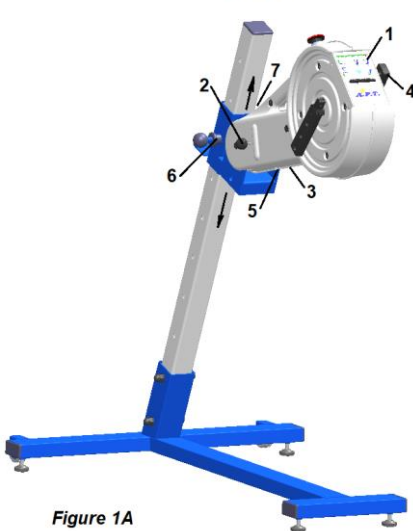

Figure 1A



Figure 1B

4.2 Primary components (Figure 2):

1. Power supply unit
2. Straight hand-grips
3. Footrests
4. Securing straps



4.3 The Type Plate

The Type Plate can be found on the underside of the **APT-1K** body next to the power input socket.



Figure 2A

This label contains the serial number of the **APT-1K**
 The serial number consists of 11 digits and one letter:
 Example: Serial no. **32001103001X**

3100	11	03	001	X
1	2	3	4	5

1. Model: **APT-1K**
2. Year of manufacturing (last two digits of the year)
3. Month of manufacturing
4. Sequential number of batch
5. Letter identifying the manufacturing location

IPX1

Liquid ingress protection level



Read this user manual and all labels before operating.



When this equipment is no longer operational it must be sent to a separate collection facility for recovery and recycling.



CE approved Notified Body No. 0123.



Type B equipment.



Read the warnings in this manual before operating.

4.4. The APT-1K - Operator Panel

Figure 3

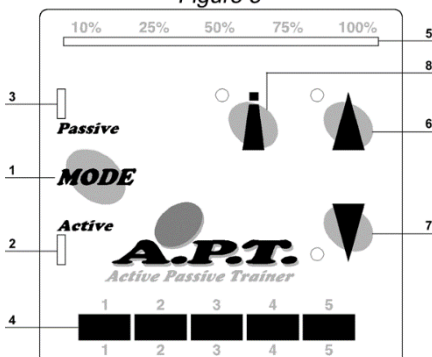





1	MODE	Operation mode Button - for selecting mode of operation.
2	Active 	Green indicator is lit when ACTIVE mode is selected by mode button.
3	Passive 	Green indicator is lit when PASSIVE mode is selected by mode button.
4	 1 2 3 4 5	Exercise level selection push switches 1 - Lowest level 5 - Highest level
5	 10% 25% 50% 75% 100%	Indicates actual load level (%)
6		Button for forward operation in the PASSIVE mode. The green indicator is lit to indicate forward operation.
7		Button for backward operation in the PASSIVE mode. The green indicator is lit to indicate backward operation.
8		Button activating Auto-Reverse function in the PASSIVE mode. In the ACTIVE mode this button activates the constant force function. The green indicator is lit when activated.

5. ACCESSORIES

The following items are designed for use in combination with the **APT-1K**.
CAUTION: The use of accessories other than these can be unsafe.

5.1. Hand grips and Footrests

#	ACCESSORY	USAGE DESCRIPTION	FIGURE
a)	Straight Handgrips	Used for most of the upper limb exercising.	
b)	Angled Handgrips	Ergonomically designed, mainly for strength exercising in the Active mode.	
c)	Hemi-glove	Used for securely supporting the wrist and hand on the handgrips for users who have little or no muscle strength.	
d)	Pediatric Hemi-glove	Hemi-glove specially designed to be used by children.	
e)	Standard Footrests	Used for most of the lower limb exercising.	
f)	Pediatric Footrest	Footrest specially designed to be used by children.	
g)	High support for footrests	May be attached to footrests for supporting the lower limbs of users that have little or no muscle strength.	

SECTION B – USER INFORMATION

6. PREPARING THE APT-1K HI-LO



6.1. Moving your *APT-1K Hi-Lo/Double*

The *APT-1K Hi-Lo/Double* can easily be moved by lifting the end of the frame and pushing the unit using its wheels, see Figure 4.

6.2. Positioning the *APT-1K Hi-Lo*

Position the *APT-1K Hi-Lo/Double* close to an electrical socket outlet. The adjustable feet on the underside keep the *APT-1K Hi-Lo/Double* level and prevent it from sliding.

NOTE: Ensure that the *APT-1K Hi-Lo/Double* is level in order to prevent damage to the trainer or its components.

If readjustment of one of the feet is needed, open the contra nut (4A/1), turn the foot (4A/2) to the desired height and secure the foot with the contra nut (4A/1).

7. INSTALLATION FOR USE – ARMS EXERCISE

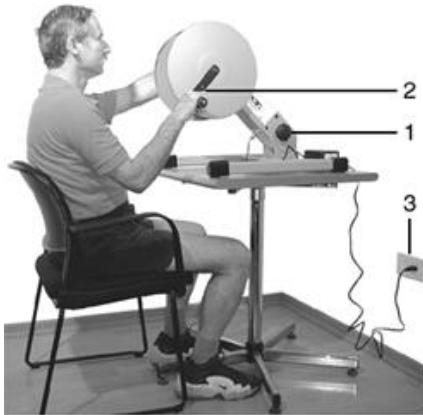

Figure 5

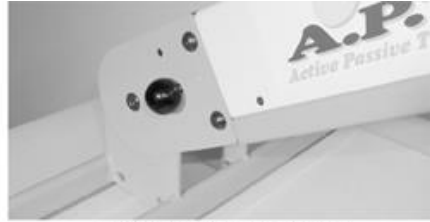

Figure 6 - angle release knob

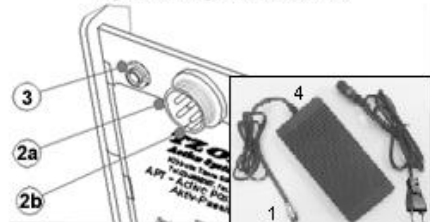

Figure 7 - power supply connector and APT socket

Step 1: Position the **APT-1K** on a level table top close to an electrical socket outlet (Figure 5).

For the **APT-1K Hi-Lo**: loosen the height securing knob (Figure 1A-7), pull the grey ring of the height release knob (Figure 1A-6) and adjust the unit to the required height. Release the grey ring and tighten the height securing knob (Figure 1A-7).

Step 2: Loosen the angle-securing knob (Figure 5-1) and adjust the **APT-1K** to the required angle. To increase the angle, lift the body of the **APT-1K**, allow it to “click” into one of the operating positions and retighten the securing knob. To decrease the angle, pull the angle release knob (Figure 6), lower the body of the **APT-1K**, allow it to “click” into another operating position and tighten the securing knob.

CAUTION: Make sure that the minimum distance between crank arm and the table surface is approximately 5 cm. / 2” (Figure 5-2).

Step 3: Connect the output connector (Figure 7-1) of the power supply (Figure 7-4) to the **APT-1K** power input socket (Figure 7-2) while ensuring correct position of connector groove opposite the guide key of socket (Figure 7-3).

NOTE: The **APT-1K** must be used only with an original **APT-1K** Power Supply unit.

Step 4: Insert handgrip (Figure 9-1) in one of the four mounting holes (Figure 9-2) in each of the **APT-1K** crank arms. Installation or removal requires only a straight push or pull while simultaneously pressing on the release pin (Figure 9-3) at the end of the handle.

NOTE: The choice of mounting hole provides variable resistance levels and ranges of motion. See operation instructions.

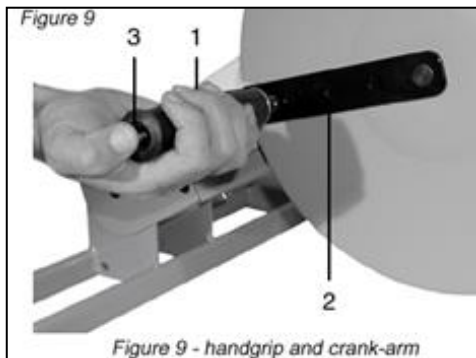

Step 5: Plug the power supply mains power plug into the electrical socket outlet (Figure 5-3). The **APT-1K** will enter a stand by position. **To start operating**, press the **MODE** button. The green ACTIVE mode indicator will light up. You may start exercising in the ACTIVE mode. For operation instructions, see 5.1 & 5.2.

NOTE: If the **APT-1K** moves across the table during arm exercises, anti-slip pads may require cleaning.

8. INSTALLATION FOR USE – LEG EXERCISE



Figure 10

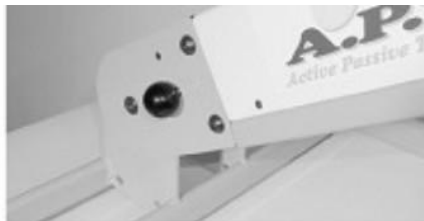

Figure 11 - angle release knob



Figure 12 - power supply connector and APT socket

Step 1: Position the **APT-1K** on the floor close to an electrical socket outlet (Figure 10).

For the **APT-1K Hi-Lo**: loosen the height securing knob (Figure 1A-7), pull the grey ring of the height release knob (Figure 1A-6) and adjust the unit to the required height.

Step 2: Loosen the angle-securing knob (Figure 10-1) and adjust the **APT-1K** to the required angle. To increase the angle, lift the body of the **APT-1K**, allow it to “click” into one of the operating positions and retighten the securing knob. To decrease the angle, pull the angle release knob (Figure 11), lower the body of the **APT-1K**, allow it to “click” into another operating position and tighten the securing knob.

CAUTION: Make sure that the minimum distance between crank arm and the floor surface is approximately 5 cm. / 2” (Figure 10-2)

Step 3: Place a chair at the desired distance from the **APT-1K**. If necessary, attach the Securing straps (Figure 10-6) between the **APT-1K** base rings (Figure 10-5) and the chair legs to prevent any change in distance between the **APT-1K** and the chair during leg exercises.

Step 4: Connect the power output connector (Figure 12-1) of the power supply (Figure 12-4) to the **APT-1K** power input socket (Figure 12-2) while ensuring correct position of connector groove opposite the guide key of socket (Figure 12-3).

NOTE: The **APT-1K** must be used only with an original **APT-1K** Power Supply unit.

Step 5: Insert Footrest (Figure 13-1) in one of the four mounting holes (Figure 13-2) in each of the **APT-1K** crank arms. Installation or removal requires only a straight push or pull while simultaneously pressing on the release pin (Figure 13-3) as shown. Secure feet in place with straps fastened diagonally as shown in Figure 10.

NOTE: The choice of mounting hole provides variable resistance levels and ranges of motion. See operation instructions.

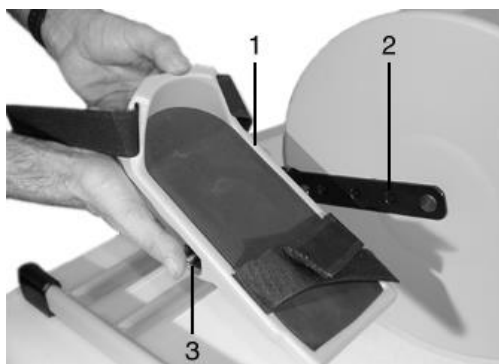

Figure 13 - footrest, crank-arm, mounting holes

Step 6: Plug the power supply mains power plug into the electrical socket outlet (Figure 10-3). The **APT-1K** will enter a stand by position. **To start operating**, press the **MODE** button. The green ACTIVE mode indicator will light up. You may start exercising in the ACTIVE mode. For operation instructions, see 5.1 & 5.2.

NOTE: If the **APT-1K** moves across the floor during leg exercises, make sure anti-slip pads (Figure 10-4) are clean. If possible – use the **APT-1K** on a carpet or rubber mat.

9. OPERATION INSTRUCTIONS

NOTE: Install **APT-1K** for arms or legs exercise as described in the previous chAPT-1Kers.

9.1. Active mode - ISOKINETIC operation

Step 1: Insert the handgrips or footrests in one of the four mounting holes according to the radius and range of motion required.

NOTE: As the effective crank arm length is reduced in the ACTIVE mode, the amount of effort required increases while the range of motion decreases, and vice versa.

Step 2: To activate the active mode from the stand by position (after the electrical power is supplied to the **APT-1K**): press the **MODE** button. The green ACTIVE mode indicator (Figure 3-2) will light up.

Step 3: Set the desired load level by pressing one of the five load selection push switches (Figure 3-4).

Step 4: Rotate the **APT-1K** handgrips or footrests forward or backward. Actual exercising force is displayed as a percentage (%) on the Bar Indicator (Figure 3-5).

NOTE: In this mode, an increase in the rotation speed (RPM) will lead to an increase in the exercising force (**Table 1, Appendix 1**).

9.2. PASSIVE mode

Step 1: Insert the handgrips or footrests in one of the four mounting holes according to the radius and range of motion required.

NOTE: As the effective crank arm length is reduced in the PASSIVE mode, the range of movement is reduced and the degree of resistance that the motor can overcome is increased.

Step 2: To activate the passive mode from the stand by position (after the electrical power is supplied to the **APT-1K**): Press the **MODE** button two times, until the green PASSIVE mode indicator (Figure 3-3) will light up. From the ACTIVE mode – press once only.

Step 3: Set the desired rotation force and speed by pressing one of the five exercise level selection push switches (Figure 3-4). 1 = lowest force, 20 rpm / 5 = highest force, 60 rpm

Step 4: Hold onto the handgrips (for arm exercise) or secure both feet to the footrests (for legs exercise). Make sure that **APT-1K** is placed at a comfortable distance for exercise by turning the crank arms one complete revolution.

Press the  button for forward rotation.

Press the  button for backward rotation.

NOTE: There will be a short delay before the **APT-1K** begins to turn in the chosen direction.

Step 5: The operation force of the crank arms should rotate the arms or legs of with no effort on the part of the user. This rotation force varies according to exercise level and crank arm mounting hole location selected (**Table 3, Appendix 1**).

Step 6: To stop the rotation of the crank-arms and exit the PASSIVE mode, press the **MODE** button. The indicators will turn off and the **APT-1K** will return to the stand-by position.

9.3. COMBINED active/passive mode

Step 1: Operate the **APT-1K** in the passive mode and work against the force of the motor by applying resistance to the rotation of the crank arms.

Step 2: The resistance force to the rotation is displayed on the on the Bar Indicator as a percentage (%) at each level.

Step 3: If the resistance force stops the crank arm rotation completely, the Bar Indicator (Figure 3-5) reaches 100% and the red indicator will light up. After holding this position for approximately 2 seconds, the crank arm rotation will stop automatically.

NOTE: To restart, Press the  button for forward rotation, or the  button for backward rotation.

9.4. Passive mode - AUTO-REVERSE function

Step 1: Push the  button to activate the AUTO-REVERSE function in the PASSIVE mode. The green indicator will light up.

Step 2: Operate the **APT-1K** as in usual passive or combined active/passive mode.

Step 3: When the resistance force stops the crank arm rotation completely, the Bar Indicator (Figure 3-5) reaches 100% and the red indicator will light up. After holding this position for approximately 2 seconds, the crank arm rotation will stop automatically. After a short delay the **DIRECTION OF ROTATION WILL BE REVERSED**. This feature also serves as an **ANTI-SPASM** function, stopping the motor in case of muscle spasm and reversing the direction of rotation after a short delay.

Step 4: As long as the  button indicator is lit, this function will continue to operate in the PASSIVE mode.

9.5. Shut down

Step 1: To turn off the **APT-1K**, from the PASSIVE mode- press the **MODE** button once. From the Active mode – press twice. The indicators will turn off and the **APT-1K** will return to its stand-by position.

Step 2: Disconnect the power from the **APT-1K** by first disconnecting the mains electrical plug from the electrical socket outlet. Disconnect Power supply output connector from the **APT-1K** power input socket.

CAUTION: For safe disconnection *always* take the mains plug out of the electrical socket before disconnecting the Power supply from the **APT-1K**.

9.6. Emergency Switch

In the event of the need to stop the **APT-1K** quickly, press the red mushroom headed button (Figure 14-1) situated on the top of the trainer body (above the control panel). This will immediately cut the electrical supply to the **APT-1K**.

The button will stay depressed and as long as it is in this position the **APT-1K** will not function.

In order to restore the electrical supply to the **APT-1K**, turn the knurled black disc underneath the red button (Figure 14-2) in the direction of the white arrow (Figure 14-3) on the red button (clockwise). The red button will then return to its original position.

The **APT-1K** may then be restarted as previously described.

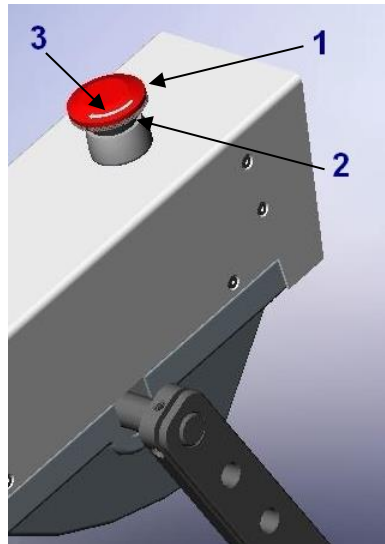

Figure 14 – Emergency Switch

10. TRANSPORTATION AND STORAGE

- ❑ The **APT-1K** can be lifted safely in its folded position by grasping onto the centre of either of the legs of the base unit and carrying like a suitcase.
- ❑ For storage in a confined space, fold the **APT-1K** unit by pulling the angle release knob (Figure 1-2) and lowering it to the flat position. Tighten the angle-securing knob (Figure 1-3) to prevent unintentional unfolding.
- ❑ Temperature range: -20°C to 40°C
- ❑ Relative humidity range: 10% to 80%
- ❑ Atmospheric pressure range: 700 hPa to 1060 hPa

11. EMI – ELECTROMAGNETIC INTERFERENCE

CAUTION: It is important that you read this information regarding the possible effects of electromagnetic interference on your **APT-1K**.

Electromagnetic Interference (EMI) From Radio Wave Sources

The equipment may be susceptible to electromagnetic interference (EMI), which is interfering electromagnetic energy (EM) emitted from sources such as radio stations, TV stations, amateur radio (HAM) transmitters, two-way radios, and cellular phones. The interference (from radio wave sources) can cause the equipment to come to a sudden stop, or react in an uncontrolled manner. It can also permanently damage the equipment's control system.

There are a number of sources of relatively intense electromagnetic fields in the everyday environment. Some of these sources are obvious and easy to avoid. Others are not apparent and exposure is unavoidable. However, we believe that by following the warnings listed below, your risk to EMI will be minimized.

The sources of radiated EMI can be broadly classified into three types:

- 1) **Hand-held portable transceivers** (transmitters-receivers) with the antenna mounted directly on the transmitting unit. Examples include citizens band (CB) radios, "walkie-talkies", security, fire, and police transceivers, cellular telephones, and other personal communication devices.
**NOTE: Some cellular telephones and similar devices transmit signals while they are ON, even when not being used;
- 2) **Medium-range mobile transceivers**, such as those used in police cars, fire trucks, ambulances, and taxis. These usually have the antenna mounted on the outside of the vehicle; and
- 3) **Long-range transmitters and transceivers**, such as commercial broadcast transmitters (radio and TV broadcast antenna towers) and amateur (HAM) radios.

NOTE: Other types of hand-held devices, such as cordless phones, laptop computers, AM/FM radios, TV sets, CD players, and cassette players, and small appliances, such as electric shavers and hair dryers, so far as we know, are not likely to cause EMI problems to the equipment.

Because EM energy rapidly becomes more intense as one moves closer to the transmitting antenna (source), the EM fields from hand-held radio wave sources (transceivers) are of special concern. It is possible to unintentionally bring high levels of EM energy very close to the equipment's control

system while using these devices. This can affect the equipment's operation. Therefore, the warnings listed below are recommended to prevent possible interference with the control system of your **APT-1K**.

WARNINGS

Electromagnetic interference (EMI) from sources such as radio and TV stations, amateur radio (HAM) transmitters, two-way radios, and cellular phones can affect the equipment. Following the warnings listed below should reduce the chance of unintended reaction, which could result in serious injury.

- 1) Use of this equipment adjacent to or stacked with other equipment should be avoided because it could result in improper operation. If such use is necessary, this equipment and the other equipment should be observed to verify that they are operating normally.”
- 2) Use of accessories, transducers and cables other than those specified or provided by the manufacturer of this equipment could result in increased electromagnetic emissions or decreased electromagnetic immunity of this equipment and result in improper operation.”
- 3) Portable RF communications equipment (including peripherals such as antenna cables and external antennas) should be used no closer than 30 cm (12 inches) to any part of the **APT-1K**, including cables specified by the manufacturer. Otherwise, degradation of the performance of this equipment could result.”
- 4) If an unintended reaction occurs, turn your **APT-1K** power switch OFF by using the emergency stop switch (see instructions on page 22);
- 5) Be aware that adding accessories or components, or modifying your **APT-1K**, may make it more susceptible to EMI (Note: There is no easy way to evaluate their effect on the overall immunity of your **APT-1K**);
- 6) Report all incidents of unintended reaction to your Authorized **APT-1K** dealer or service center, and note whether there is a source of EMI nearby.

Declaration – electromagnetic emissions		
Emissions test	Compliance	Electromagnetic environment – guidance
RF emissions CISPR 11	Group1 Class B	The APT-1K uses RF energy only for its internal function. Therefore, its RF emissions are very low and are not likely to cause any interference in nearby electronic equipment.
Harmonic emissions IEC 61000-3-2	Class A	The APT-1K is suitable for use in all establishments, including domestic establishments and those directly connected to the public low voltage power supply network that supplies buildings used for domestic purposes.
Voltage Fluctuations And Flicker IEC 61000-3-3:2013	Complies	

Declaration – electromagnetic immunity			
IMMUNITY test	IEC 60601 test level	Compliance level	Electromagnetic environment – guidance
Electrostatic discharge (ESD) IEC 61000-4-2	8 kV contact 2, 4, 8, 15kV air	8 kV contact 2, 4, 8, 15kV air	Floors should be wood, concrete or ceramic tile. If floors are covered with synthetic material, the relative humidity should be at least 30 %.
Electrical fast transient/burst IEC 61000-4-4	2 kV for power supply lines 1 kV for input/output lines	2 kV for power supply lines N/A	Mains power quality should be that of a typical commercial or hospital environment.
Surge IEC 61000-4-5	1 kV line(s) to line(s) 2 kV line(s) to earth 2 kV Signal input/output) to earth	1 kV line(s) to line(s) 2 kV line(s) to earth N/A	Mains power quality should be that of a typical commercial or hospital environment.
Voltage dips, short interruptions and voltage variations on power supply input lines IEC 61000-4-11	0% UT; 0.5cycle at 0°, 45°, 90°, 135°,180°, 225°, 270° and 315° 0% UT; 1cycle and 70% UT; 25/30 cycles Single phase at 0° 0% UT; 250/300 cycle	0% UT; 1cycle and 70% UT; 25/30 cycles Single phase at 0° 0% UT; 250/300 cycle	Mains power quality should be that of a typical commercial or hospital environment. If the user of the APT-1K requires continued operation during power mains interruptions, it is recommended that the APT-1K be powered from an uninterruptible power supply or a battery.
Power frequency (50/60 Hz) magnetic field IEC 61000-4-8	30 (A/m)	30 (A/m)	Power frequency magnetic fields should be at levels characteristic of a typical location in a typical commercial or hospital environment.
NOTE UT is the a.c. mains voltage prior to application of the test level.			

Declaration – electromagnetic immunity			
IMMUNITY test	IEC 60601 TEST LEVEL	Compliance level	Electromagnetic environment – guidance
Conducted RF IEC 61000-4-6	3V, 6V	3Vrms, 6V	Portable and mobile RF communications equipment should be used no closer to any part of the APT-1K , including cables, than the recommended separation distance calculated from the equation applicable to the frequency of the transmitter. Recommended separation distance $d = \left[\frac{3,5}{V_1} \right] \sqrt{P}$ $d = \left[\frac{12}{V_2} \right] \sqrt{P}$
	3V/m	3V/m	
Radiated RF IEC 61000-4-3	3V from 0.15 to 80MHz; 6V from 0.15 to 80MHz and 80% AM at 1kHz	3V from 0.15 to 80MHz; 6V from 0.15 to 80MHz and 80% AM at 1kHz	$d = \left[\frac{12}{E_1} \right] \sqrt{P} \quad 80 \text{ MHz to } 800 \text{ MHz}$ $d = \left[\frac{23}{E_1} \right] \sqrt{P} \quad 800 \text{ MHz to } 2,5 \text{ GHz}$ <p>where P is the maximum output power rating of the transmitter in watts (W) according to the transmitter manufacturer and d is the recommended separation distance in metres (m).</p> <p>Field strengths from fixed RF transmitters, as determined by an electromagnetic site survey, should be less than the compliance level in each frequency range.</p> <p>D Interference may occur in the vicinity of equipment marked with the following symbol:</p> 
	10V/m from 80MHz to 2.7GHz	10V/m from 80MHz to 2.7GHz	

Recommended separation distances between portable and mobile RF communications equipment and the APT-1K				
Rated maximum output power of transmitter W	Separation distance according to frequency of transmitter m			
	150 kHz to 80 MHz outside ISM bands $d = [\frac{3,5}{V_1}] \sqrt{P}$	150 kHz to 80 MHz in ISM bands $d = [\frac{12}{V_2}] \sqrt{P}$	80 MHz to 800 MHz $d = [\frac{12}{E_1}] \sqrt{P}$	800 MHz to 2,5 GHz $d = [\frac{23}{E_1}] \sqrt{P}$
0.01	0.12	0.2	0.4	1
0.1	0.37	0.64	1.3	2.6
1	1.17	2	4	8
10	3.7	6.4	13	26
100	11.7	20	40	80

Test specifications for ENCLOSURE PORT IMMUNITY to RF wireless communications equipment							
Test frequency (MHz)	Band ^{a)} (MHz)	Service ^{a)}	Modulation ^{b)}	Maximum power (W)	Distance (m)	IMMUNITY TEST LEVEL (V/m)	Compliance level (V/m)
385	380 – 390	TETRA 400	Pulse modulation ^{b)} 18 Hz	1.8	0.3	27	27
450	430 – 470	GMRS 460, FRS 460	FM ^{c)} ± 5 kHz deviation 1 kHz sine	2	0.3	28	28
710	704 – 787	LTE Band 13, 17	Pulse modulation ^{b)} 217 Hz	0.2	0.3	9	9
745							
780							
810	800 – 960	GSM 800/900, TETRA 800, iDEN 820, CDMA 850, LTE Band 5	Pulse modulation ^{b)} 18 Hz	2	0.3	28	28
870							
930							
1720	1 700 – 1 990	GSM 1800; CDMA 1900; GSM 1900; DECT; LTE Band 1, 3, 4, 25; UMTS	Pulse modulation ^{b)} 217 Hz	2	0.3	28	28
1845							
1970							
2450	2 400 – 2 570	Bluetooth, WLAN, 802.11 b/g/n, RFID 2450, LTE Band 7	Pulse modulation ^{b)} 217 Hz	2	0.3	28	28
5240	5 100 – 5 800	WLAN 802.11 a/n	Pulse modulation ^{b)} 217 Hz	0.2	0.3	9	9
5500							
5785							
NOTE: If necessary to achieve the IMMUNITY TEST LEVEL, the distance between the transmitting antenna and the ME EQUIPMENT or ME SYSTEM may be reduced to 1 m. The 1 m test distance is permitted by IEC 61000-4-3.							
^{a)} For some services, only the uplink frequencies are included. ^{b)} The carrier shall be modulated using a 50 % duty cycle square wave signal. ^{c)} As an alternative to FM modulation, 50 % pulse modulation at 18 Hz may be used because while it does not represent actual modulation, it would be worst case.							

SECTION C – SERVICE INFORMATION

12. GENERAL MAINTENANCE INSPECTIONS & STORAGE

The rugged design of the **Active Passive Trainer** and the use of selected, modern materials ensure minimal requirements for care and maintenance. The **APT-1K** can be lifted safely in its folded position by grasping on to the centre of either of the legs of the base and carrying like a suitcase.

NOTE: Improper handling or neglect in the care of the **Active Passive Trainer** may reduce or cancel the coverage of the manufacturer's warranty.

12.1. Regular care

- Inspect Power supply cables and plug for visible damages.
- Check power-input connector for visible damage or insecure fastening.
- On a regular basis check that all screws and components are fastened tightly.
- Ensure that the anti-slip pads under the base are always kept clean.

CAUTION: If any damage is detected – do not use **APT-1K**. Please contact your authorized dealer. Only authorized personnel may carry out repairs.

12.2. Cleaning instructions

- Disconnect Power Supply and wipe dry with clean cloth.

CAUTION: For safe disconnection of the **APT-1K** *always* take the mains plug out of the wall socket *before* removing the connector from the **APT-1K** power socket.

- Take care not to allow water to enter the unit. Keep cables and electric components away from water and humidity.

12.3. Storage

- Store the **APT-1K** between –20 and +40 degrees C and between 10% and 80% humidity.
- For storage in a confined space, fold the **APT-1K** unit by pulling the angle release knob (Figure 1-2) and lowering it to the flat position. Tighten the angle-securing knob (Figure 1-3) to prevent unintentional unfolding.

13. DISPOSAL AND RECYCLING

The packing material must be separated to plastic and paper/cardboard components and submitted to authorized recycling locations.

The **APT-1K** device consists of electronic components, cables, plastic parts, steel body and base frame, and aluminium parts. Do not discard any components to normal refuse facilities. When **APT-1K** is no longer operational, it is to be dismantled and separated into above material groups and submitted to authorized recycling facilities.



14. TROUBLE-SHOOTING

Hereunder are some types of disorders, which can usually be repaired rather simply. If these following measures are unsuccessful, an authorized dealer should be contacted!

PROBLEM	CHECK POINT
<p>The APT-1K does not function at all</p>	<p>Power Supply not connected properly to mains outlet or to the APT-1K.</p>
	<p>APT-1K in standby mode. Press the  button to enter active or passive modes.</p>
	<p>(Models with Stop-switch) Stop switch in lower - disconnection position. Turn switch anti-clockwise to release.</p>
<p>The crank-arms do not start to rotate in the passive mode</p>	<p>No load/speed selection button is selected (pushed inwards)</p> <p>(Models with Independent Speed controller) Speed control Knob is in the "0" (off) position. Turn knob clockwise to desired exercise speed.</p>
<p>Models with remote control: remote unit not functioning smoothly</p>	<p>Remote unit's transmitter LED needs to be wiped clean</p>
	<p>Remote unit batteries need replacement</p>

15. APPENDIX

Table 1: Active Mode ISOKINETIC operation

Level			25%		50%		75%		100%	
			oz.	Kg.	oz.	Kg.	oz.	Kg.	oz.	Kg.
1	Force	R1	5.0	0.15	6	0.2	13	0.35	25	0.75
		R2	7.5	0.2	9	0.3	20	0.6	40	1.2
		R3	15	0.4	18	0.5	40	1.2	80	2.3
	Power Speed	Watts	0.5		1		3		9	
RPM		30		50		65		100		
2	Force	R1	10	0.3	12	0.35	28	0.8	53	1.5
		R2	15	0.4	18	0.5	42	1.2	80	2.3
		R3	30	0.85	36	1.0	84	2.4	160	4.6
	Power Speed	Watts	1		2		6		18	
RPM		30		50		65		100		
3	Force	R1	20	0.6	24	0.7	56	1.6	110	3.0
		R2	30	0.85	36	1.0	86	2.4	160	4.6
		R3	60	1.7	72	2.0	170	4.7	320	9.2
	Power Speed	Watts	2		4		12		36	
RPM		30		50		65		100		
4	Force	R1	40	1.1	48	1.4	110	3.2	220	6.0
		R2	60	1.7	70	2.0	170	4.7	320	9.2
		R3	120	3.4	140	4.0	340	9.5	640	18.5
	Power Speed	Watts	4		8		24		72	
RPM		30		50		65		100		
5	Force	R1	80	2.3	95	2.7	220	6.2	430	12
		R2	120	3.4	145	4.1	330	9.3	650	18
		R3	240	6.8	290	8.2	660	18.5	1300	36
	Power Speed	Watts	8		16		48		144	
RPM		30		50		65		100		

NOTE: Force Levels are indicated for Mounting Hole locations R1, R2, R3 on crank-arms (Figure 9 / Figure 13).

Table 2: Active Mode CONSTANT FORCE operation

Level			50%	
			oz.	Kg.
1	Force	R1	6	0.17
		R2	9	0.25
		R3	18	0.50
2	Force	R1	12	0.3
		R2	18	0.5
		R3	36	1.0
3	Force	R1	24	0.7
		R2	36	1.0
		R3	72	2.0
4	Force	R1	48	1.4
		R2	70	2.0
		R3	140	4.0
5	Force	R1	96	2.7
		R2	140	4.0
		R3	280	8.0

NOTE: Force Levels are indicated for Mounting Hole locations R1, R2, R3 on crank-arms (Figure 9 / Figure 13).

Table 3: Passive Mode

Level			0%	25%		50%		75%		100%	
				oz.	Kg.	oz.	Kg.	oz.	Kg.	oz.	Kg.
1	Force	R1	0	33	0.95	67	1.9	100	2.8	135	3.7
		R2	0	50	1.4	100	2.8	150	4.3	200	5.6
		R3	0	100	2.8	200	5.6	300	8.5	400	11.2
	Speed	RPM	20	15		10		5		0	
2	Force	R1	0	43	1.20	84	2.4	125	3.6	170	4.7
		R2	0	65	1.80	125	3.5	190	5.4	250	7.0
		R3	0	130	3.60	250	7.0	380	10.7	500	14
	Speed	RPM	30	23		15		8		0	
3	Force	R1	0	51	1.4	100	2.8	145	4.1	200	5.0
		R2	0	75	2.1	150	4.2	215	6.1	300	8.4
		R3	0	150	4.3	300	8.4	430	12.2	600	16.9
	Speed	RPM	40	30		20		10		0	
4	Force	R1	0	59	1.7	115	3.3	175	5.0	253	6.6
		R2	0	88	2.5	175	5.0	265	7.4	350	9.8
		R3	0	175	5.0	350	10	530	15	700	19.7
	Speed	RPM	50	38		25		13		0	
5	Force	R1	0	67	1.9	133	3.7	200	5.6	267	7.5
		R2	0	100	2.8	200	5.6	300	8.4	400	11.3
		R3	0	200	5.6	400	11.3	600	16.9	800	22.5
	Speed	RPM	60	45		30		15		0	

NOTE: Force Levels are indicated for Mounting Hole locations R1, R2, R3 on crank-arms (Figure 9 / Figure 13).

WARRANTY

The warranty period for the **APT-1K** is twelve months and covers faulty materials and workmanship (consumables not covered: plastic coverings and batteries). Worn parts damaged as a result of excessive loading, improper handling, intentional damage or unauthorized maintenance or modification are not covered by the warranty.

For safety and for warranty assurance reasons, any modifications and repair of the **APT-1K** or its components must be performed exclusively by authorized personnel and exclusively with original spare parts.



Kibbutz Tzora,
99803, Israel
Web site: www.tzora.com



MDI Europa GmbH
Langenhagener Straße 71,
D-30855 Langenhagen,
Germany